

ORIS  
LIGHTING

# НАТЯЖНОЙ ПОТОЛОК МАГНИТНАЯ СИСТЕМА НАПРАВЛЕНИЯ

## CONTACT INFORMATION



Zhongshan Oris Lighting Co., Ltd

Location: Libit Building B ,Tongshun Industrial Park, Guzhen Town, ZhongShan City ,China

Tell: +86-17329639326

Email: sales1@orislighting.com

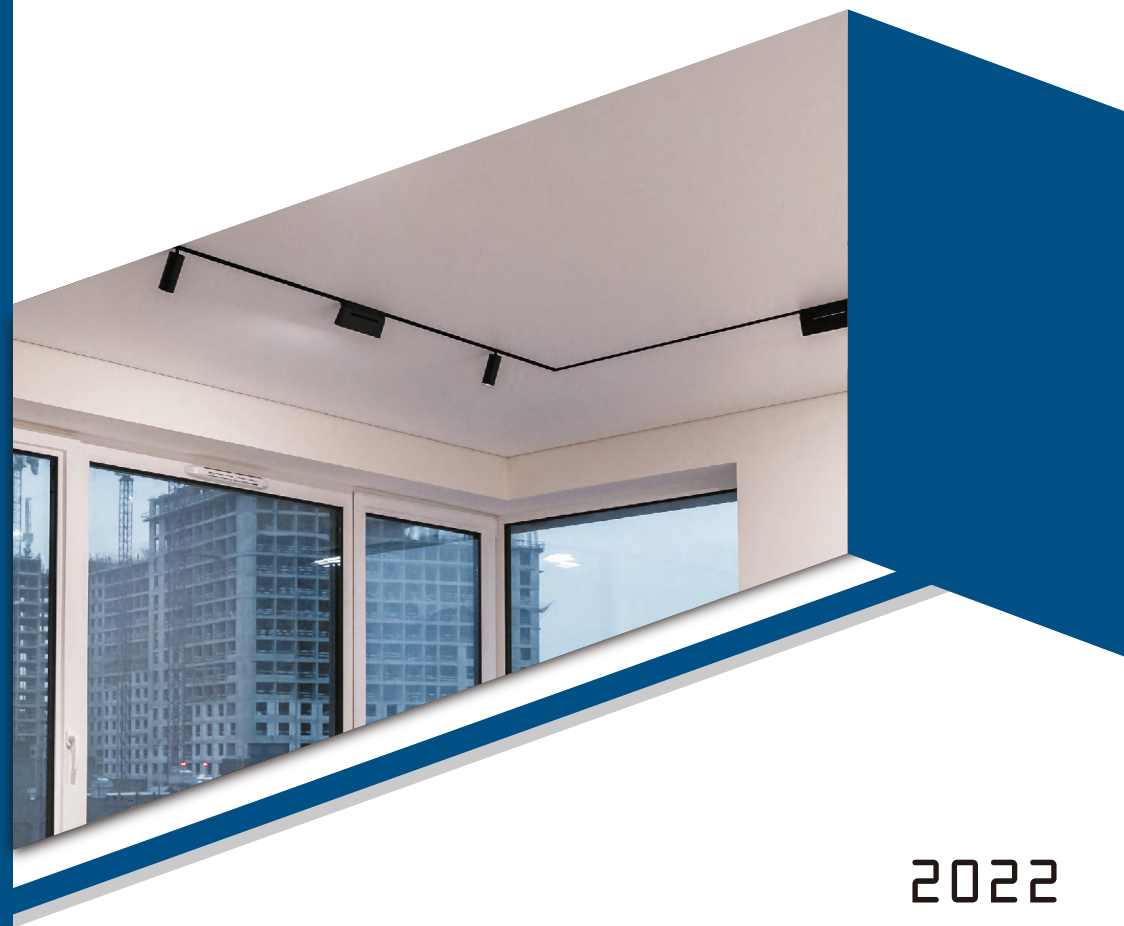

Самый главный плюс продукта - это альянс профиля и шинпровода на магнитной системе с демпферным креплением.

Система демпфирования позволяет реализовать трековые системы в ПВХ и тканевых потолках.

Новая гусеница сочетает в себе силуэт эластичной ткани и гусеницей, питающей светильники.

Это комплексное решение, которое решает проблему потолков и организации освещения.



## 01 Интегрированные профили

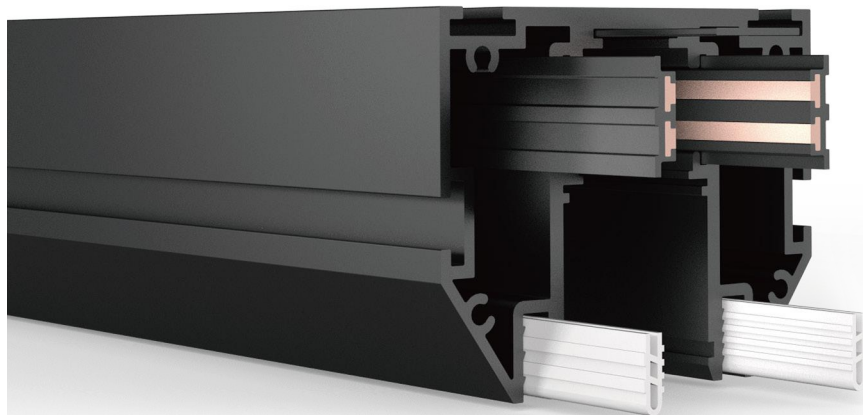

Профиль изготовлен из высококачественного алюминиевого сплава с качественной порошковой окраской. Безопасность рельсовой системы обеспечивается низковольтным блоком питания 48В.

## 02 Соответствующая заглушка

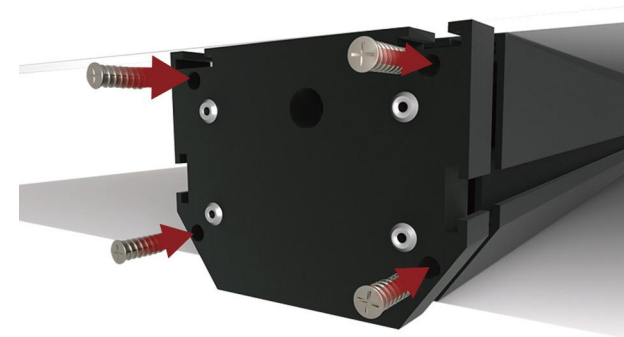

Специально разработанные торцевые заглушки для демпферов для легкой установки.

## 03 Конструкция демпфера

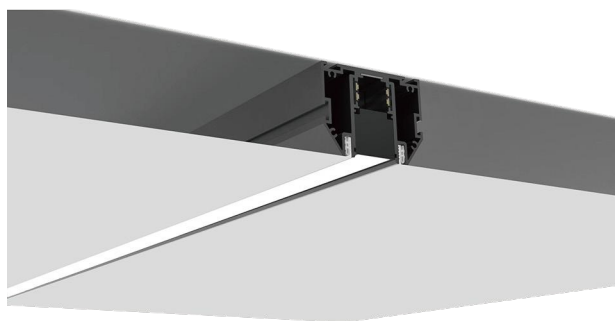

В демпфере используется высококачественный экологически чистый силикон, подходит для ПВХ и тканевых потолков, не имеет запаха и не желтеет при длительном использовании.

Силиконовый демпфер

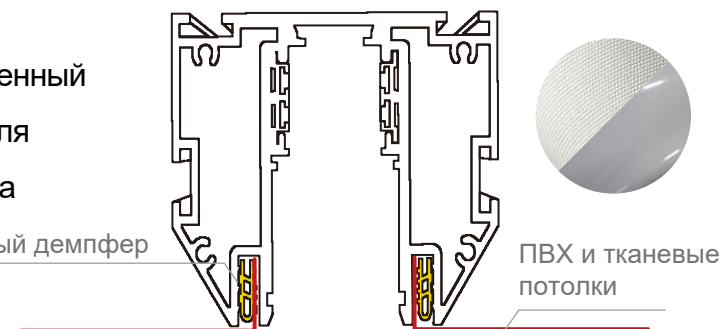

ПВХ и тканевые потолки

## 04 Подключение и фиксация аксессуаров



Металлический соединительный элемент, простой и надежный в установке.

## 05 Бесплатное сращивание

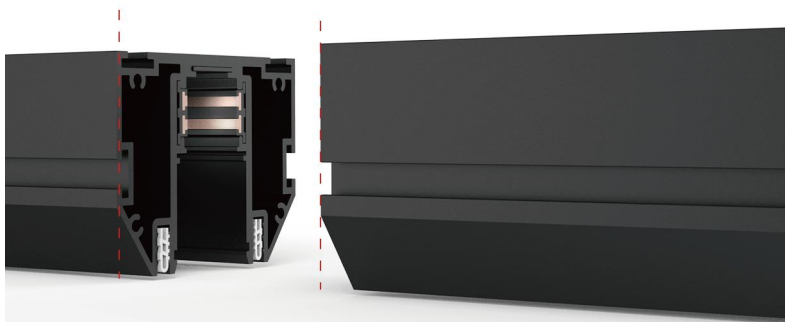

Он может быть склеен в различные формы по желанию, чтобы адаптироваться к различным сценариям.

## 06 Два метода сращивания углов

Plan A

Место установки профиля вырезается под углом 45 градусов и фиксируется соединительным элементом под углом 90 градусов.

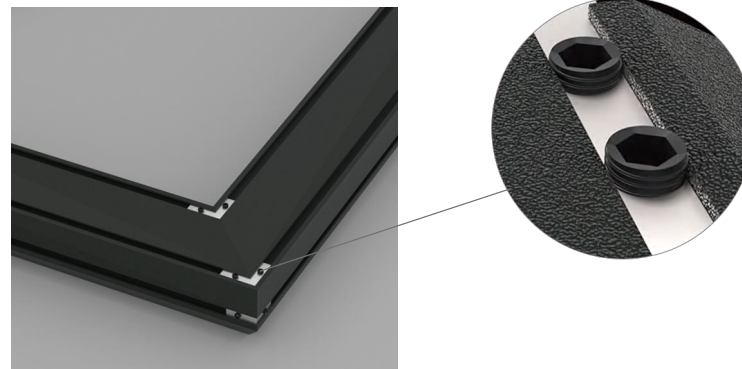

Plan B

Фабрика изготовила уголок 10\*10см, который можно использовать прямо на месте установки.





## Доступны два силовых преобразователя

Отслеживайте встроенный импульсный источник питания

Model	Size	Power	Vout	Vin	Install Type	Color
LV100W48CGC1	235*22*25mm	100W	48V	220-240VAC	Internal installation	● ○

Model	Size	Power	Vout	Vin	Install Type	Color
LV200W48CGC1	235*22*25mm	200W	48V	220-240VAC	Internal installation	● ○

## Внешний импульсный источник питания

Model	Size	Adjustable Angel	Install Type	Color
MA-C005	78×18×16mm	0 -360 degree	flexible connector wire 150mm	● ○

Model	Power	Vout	Vin	Install Type
LRS-35/50/75/100/150/200/350-48	35/50/75/100/150/200/350W	48V	input 220-240VAC	External installation







Легко перемещается



Угол наклона можно свободно изменять



Лампа устанавливается путем магнитного всасывания, с собственной пряжкой переключателя

# Умное затемнение



Система поддерживает диммирование и цветовую температуру 0-10V, DALI, CASAMBI, TUYA и другие протоколы;

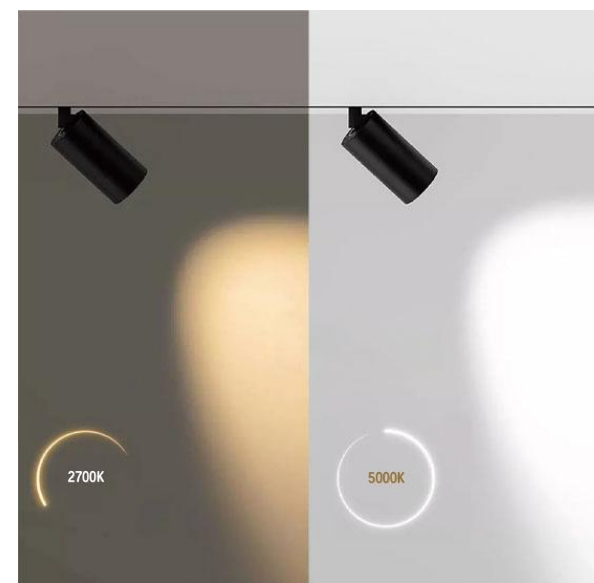
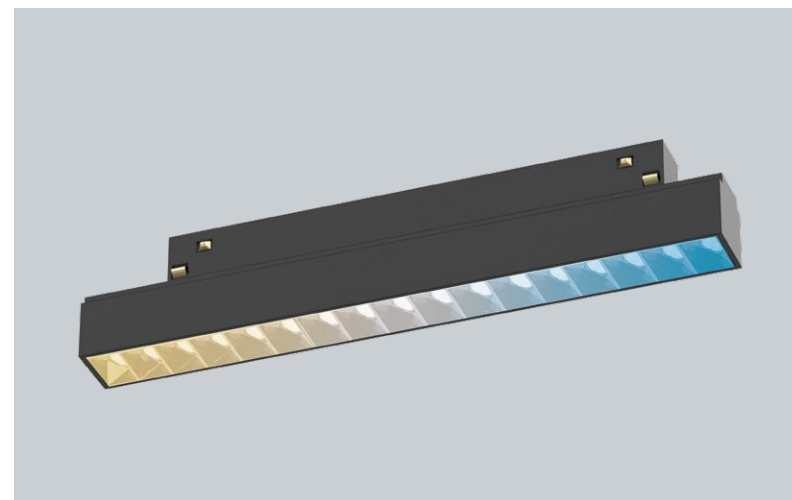



# СВЕТОДИОДНЫЙ ТРЕКОВЫЙ СВЕТИЛЬНИК

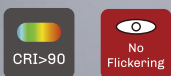

## MA-X102 COLOUR | BK ■ WH □ GD ■ BK+GD ■ WH+GD ■

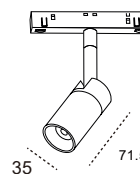

Size	φ35*71.5mm	Power	5W
Light Source	CREE 1304	Ra	Ra90
Beam Angle	15°/24°/38°	Voltage	48VDC
Dimmer Optional	0-10v/DALI/Tuya	Material	aluminium
CCT	2700K/3000K/3500K/4000K/5700K		

## MA-X103B COLOUR | BK ■ WH □ GD ■ BK+GD ■ WH+GD ■

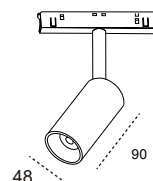

Size	φ48*90mm	Power	7W
Light Source	CREE	Ra	Ra90
Beam Angle	15°/24°/38°	Voltage	48VDC
Dimmer Optional	0-10v/DALI/Tuya	Material	aluminium
CCT	2700K/3000K/3500K/4000K/5700K		

## MA-X103C COLOUR | BK ■ WH □ GD ■ BK+GD ■ WH+GD ■

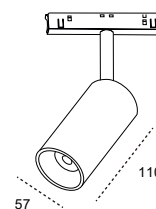

Size	φ57*110mm	Power	20W
Light Source	CREE	Ra	Ra90
Beam Angle	15°/24°/38°	Voltage	48VDC
Dimmer Optional	0-10v/DALI/Tuya	Material	aluminium
CCT	2700K/3000K/3500K/4000K/5700K		

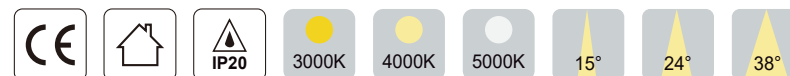



## MA-X201

COLOUR | BK ■ WH □ GD ■ BK+GD ■ WH+GD ■

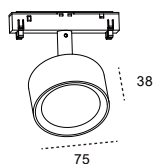

Size	φ75*38mm	Power	7-10W
Light Source	CREE	Ra	Ra90
Beam Angle	15°/24°/36°	Voltage	48VDC
Dimmer Optional	0-10v/DALI/Tuya	Material	aluminium
CCT	2700K/3000K/3500K/4000K/5700K		

## MA-X105

COLOUR | BK ■ WH □ GD ■ BK+GD ■ WH+GD ■

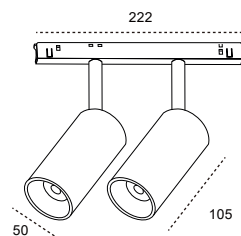

Size	222*50*105mm	Power	2*5W
Light Source	CREE	Ra	Ra90
Beam Angle	15°/24°/36°	Voltage	48VDC
Dimmer Optional	0-10v/DALI/Tuya	Material	aluminium
CCT	2700K/3000K/3500K/4000K/5700K		



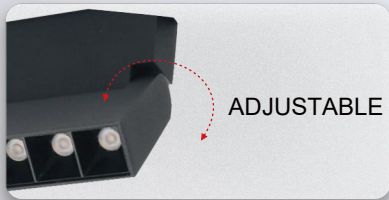

ADJUSTABLE

# СВЕТОДИОДНЫЙ СКЛАДНОЙ ФОНАРЬ

## MA-S101

COLOUR | BK ■ WH □ GD ■

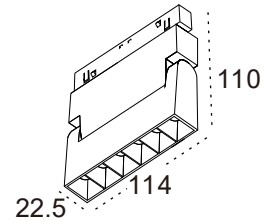

Size	114*22.5*H110mm	Power	6W
Light Source	OSRAM 2835	Ra	Ra90
Beam Angle	15°/24°/38°	Voltage	48VDC
Dimmer Optional	0-10v/DALI/Tuya	Material	aluminium
CCT	2700K/3000K/3500K/4000K/5700K		

## MA-S102

COLOUR | BK ■ WH □ GD ■

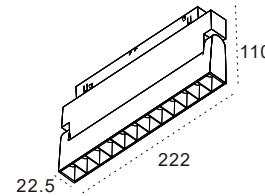

Size	222*22.5*H110mm	Power	12W
Light Source	OSRAM 2835	Ra	Ra90
Beam Angle	15°/24°/38°	Voltage	48VDC
Dimmer Optional	0-10v/DALI/Tuya	Material	aluminium
CCT	2700K/3000K/3500K/4000K/5700K		





### MA-S103

COLOUR | BK ■ WH □ GD ■

Size	114*22.5*H110mm	Power	6W
Light Source	OSRAM 2835	Ra	Ra90
Beam Angle	120°	Voltage	48VDC
Dimmer Optional	0-10v/DALI/Tuya	Material	aluminium
CCT	2700K/3000K/3500K/4000K/5700K		



### MA-S104

COLOUR | BK ■ WH □ GD ■

Size	222*22.5*H110mm	Power	12W
Light Source	OSRAM 2835	Ra	Ra90
Beam Angle	120°	Voltage	48VDC
Dimmer Optional	0-10v/DALI/Tuya	Material	aluminium
CCT	2700K/3000K/3500K/4000K/5700K		

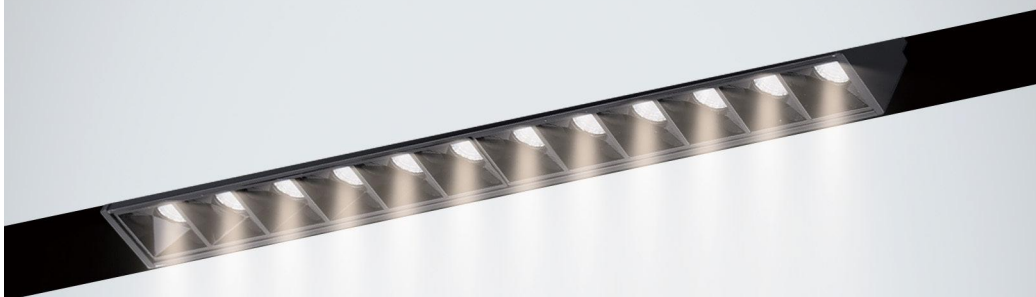

# СВЕТОДИОДНАЯ ЛИНЕЙНАЯ РЕШЕТКА

## MA-L101

COLOUR | BK ■ WH □ GD ■



Size	110mm*23mm*H47mm	Power	6W
Light Source	OSRAM 3030	Ra	Ra90
Beam Angle	15°/24°/38°	Voltage	48VDC
Dimmer Optional	0-10v/DALI/Tuya	Material	aluminium
CCT	2700K/3000K/3500K/4000K/5700K		

## MA-L102

COLOUR | BK ■ WH □ GD ■



Size	220mm*23mm*H47mm	Power	10W
Light Source	OSRAM 3030	Ra	Ra90
Beam Angle	15°/24°/38°	Voltage	48VDC
Dimmer Optional	0-10v/DALI/Tuya	Material	aluminium
CCT	2700K/3000K/3500K/4000K/5700K		

## MA-L103

COLOUR | BK ■ WH □ GD ■



Size	435mm*23mm*H47mm	Power	20W
Light Source	OSRAM 3030	Ra	Ra90
Beam Angle	15°/24°/38°	Voltage	48VDC
Dimmer Optional	0-10v/DALI/Tuya	Material	aluminium
CCT	2700K/3000K/3500K/4000K/5700K		



Multiple sizes are optional

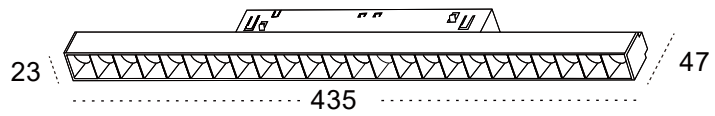
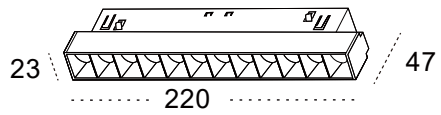
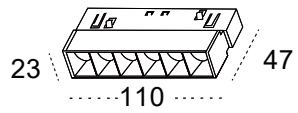

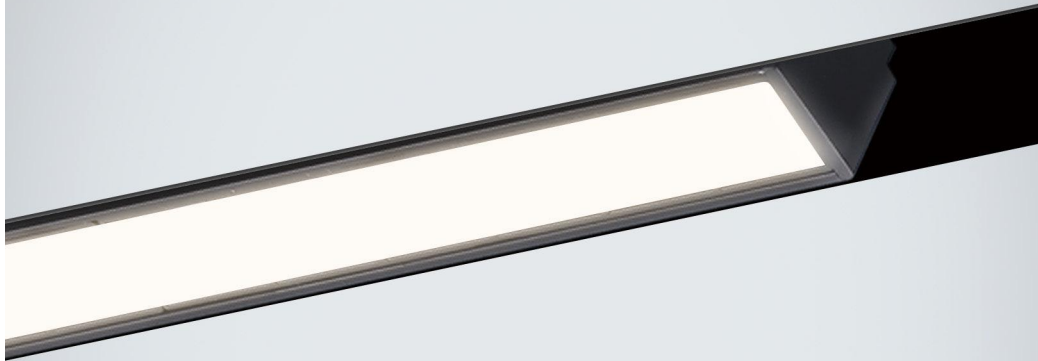

СВЕТОДИОДНЫЙ ЛИНЕЙНЫЙ СВЕТ



### MA-L201

COLOUR | BK ■ WH □ GD ■

Size	300mm*20mm*H48mm	Power	10W
Light Source	OSRAM 3030	Ra	Ra90
Beam Angle	120°	Voltage	48VDC
Dimmer Optional	0-10v/DALI/Tuya	Material	aluminium
CCT	2700K/3000K/3500K/4000K/5700K		



### MA-L202

COLOUR | BK ■ WH □ GD ■

Size	600mm*23mm*H48mm	Power	20W
Light Source	OSRAM 3030	Ra	Ra90
Beam Angle	120°	Voltage	48VDC
Dimmer Optional	0-10v/DALI/Tuya	Material	aluminium
CCT	2700K/3000K/3500K/4000K/5700K		



### MA-L203

COLOUR | BK ■ WH □ GD ■

Size	900mm*23mm*H48mm	Power	30W
Light Source	OSRAM 3030	Ra	Ra90
Beam Angle	120°	Voltage	48VDC
Dimmer Optional	0-10v/DALI/Tuya	Material	aluminium
CCT	2700K/3000K/3500K/4000K/5700K		



### MA-L204

COLOUR | BK ■ WH □ GD ■

Size	1200mm*23mm*H48mm	Power	35W
Light Source	OSRAM 3030	Ra	Ra90
Beam Angle	120°	Voltage	48VDC
Dimmer Optional	0-10v/DALI/Tuya	Material	aluminium
CCT	2700K/3000K/3500K/4000K/5700K		



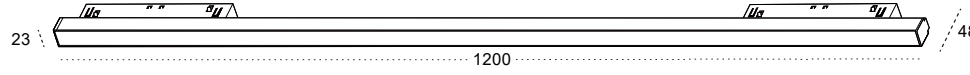
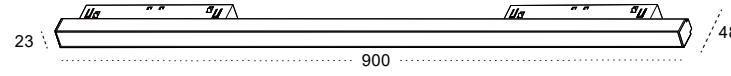
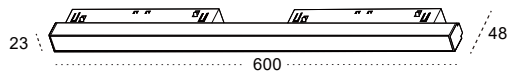
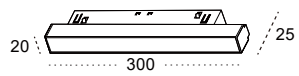

Multiple sizes are optional



# СВЕТОДИОДНЫЙ ЛИНЕЙНЫЙ УГЛОВОЙ СВЕТИЛЬНИК



## MA-L205

COLOUR | BK ■ WH □ GD ■



Size	300*300*H48mm	Power	20W
Light Source	OSRAM 3030	Ra	Ra90
Beam Angle	120°	Voltage	48VDC
Dimmer Optional	0-10v/DALI/Tuya	Material	aluminium
CCT	2700K/3000K/3500K/4000K/5700K		

## MA-L206

COLOUR | BK ■ WH □ GD ■



Size	300*48*H300mm	Power	20W
Light Source	OSRAM 3030	Ra	Ra90
Beam Angle	120°	Voltage	48VDC
Dimmer Optional	0-10v/DALI/Tuya	Material	aluminium
CCT	2700K/3000K/3500K/4000K/5700K		

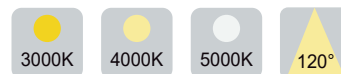



Multiple sizes are optional

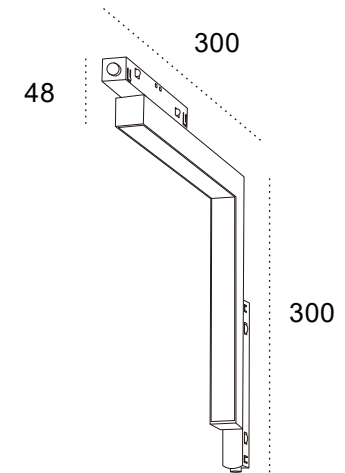
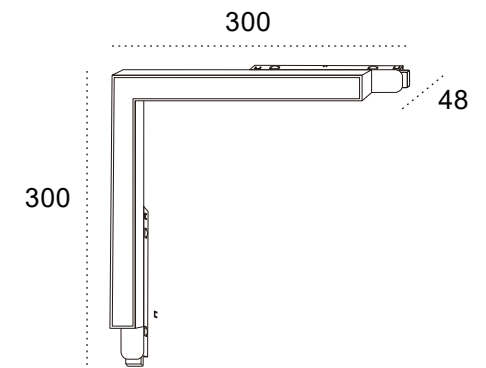



СВЕТОДИОДНЫЙ ПОДВЕСНОЙ  
СВЕТИЛЬНИК

## MA-P101

COLOUR | BK ■ WH □ GD ■

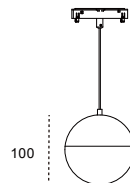

Size	100mm	Power	2*5/10W
Light Source	CREE 1304	Ra	Ra90
Beam Angle	15°/24°/36°	Voltage	48VDC
Dimmer Optional	0-10v/DALI/Tuya	Material	aluminium
CCT	2700K/3000K/3500K/4000K/5700K		

## MA-P104

COLOUR | BK ■ WH □ GD ■

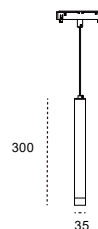

Size	235*300mm	Power	5-7w
Light Source	CREE	Ra	Ra90
Beam Angle	15°/24°/36°	Voltage	48VDC
Dimmer Optional	0-10v/DALI/Tuya	Material	aluminium
CCT	2700K/3000K/3500K/4000K/5700K		

## MA-P105

COLOUR | BK ■ WH □ GD ■

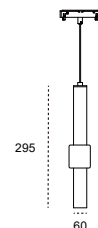

Size	60*295mm	Power	10W
Light Source	CREE	Ra	Ra90
Beam Angle	15°/24°/38°	Voltage	48VDC
Dimmer Optional	0-10v/DALI/Tuya	Material	aluminium
CCT	2700K/3000K/3500K/4000K/5700K		





## MA-P102

COLOUR | BK ■ WH □ GD ■

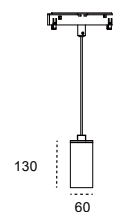

Size	60*130mm	Power	10W
Light Source	CREE	Ra	Ra90
Beam Angle	15°/24°/36°	Voltage	48VDC
Dimmer Optional	0-10v/DALI/Tuya	Material	aluminium
CCT	2700K/3000K/3500K/4000K/5700K		

## MA-P103

COLOUR | BK ■ WH □ GD ■

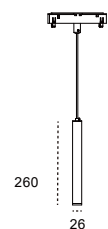

Size	26*260mm	Power	3w
Light Source	CREE	Ra	Ra90
Beam Angle	15°/24°/36°	Voltage	48VDC
Dimmer Optional	0-10v/DALI/Tuya	Material	aluminium
CCT	2700K/3000K/3500K/4000K/5700K		

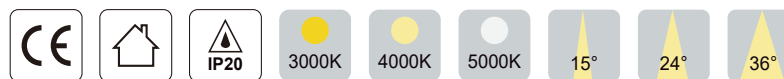

ORIS  
LIGHTING

